

This heater is approved for outdoor use only.



**SUPAGAS**  
YES WE CAN!

# Patio Heater

## Safety warnings and operating instructions

(please read all instructions carefully).

### Safety Warnings - (use only with LP Gas)

- This appliance must NOT be used indoors. **OUTDOOR USE ONLY**
- Installation must comply with local authority requirements.
- Minimum clearances **MUST** be maintained from combustible materials: 1200mm (top, sides and rear) e.g. Overhead structures, walls furniture, fixtures and plants.
- This appliance must NOT be used in a building, garage or any other enclosed area.
- This appliance must only be used in a well ventilated area.
- This appliance must be placed on firm level ground.
- Do not install in very windy locations.
- Improper installation, adjustment, or alteration can cause personal injury, property damage, or even death.
- Do not transport or move appliance while it is operating.
- If the appliance fails to operate correctly, contact place of hire or their authorised agent for advice and service. **DO NOT ATTEMPT REPAIRS YOURSELF**
- Do not place articles on or against this appliance.
- Do not store chemicals or flammable materials in the vicinity of this appliance.
- Do not spray aerosols or flammable materials in vicinity of appliance while it is operating.
- This appliance is NOT intended to be installed on recreational vehicles and/or boats.
- This appliance is NOT suitable for a marine environment.

### Operating Instructions:

#### Turning the appliance on:

1. Before lighting, ensure the heater is situated on a firm level surface.
2. Lift the gas cylinder tank housing.
3. Check the connection which screws into the LP Gas cylinder. Make sure the rubber seal is in position (end of the regulator) and not cracked or damaged in any way.
4. Screw regulator assembly to gas cylinder and make sure connection is tight. This is a lefthand thread - turn counter clockwise to tighten.
5. Turn LP Gas cylinder valve counter clockwise to the **OPEN** position.
6. Check for leaks by applying soapy water (using non-ammonia based detergent) with spray bottle or soft cloth to LP Gas connections. A gas leak is indicated when bubbles appear in the soapy water.
7. Press and turn the control knob to **HI** position, and while holding the control knob in, press direct ignition button several times until burner flame ignites. Hold the control knob for a further 10 seconds then release.
8. Turn control knob to desired temperature level.
9. Lower gas cylinder tank housing.
10. If the burner flame extinguishes accidentally turn the control knob to **OFF** position, then repeat steps 7 to 9 to light again.

#### Turning the appliance off:

1. Turn LP Gas cylinder valve clockwise to the **CLOSE** position - this will burn off any gas left in the line.
2. Press and turn the control knob clockwise to the **OFF** position.



## WARNING

After turning heater off, you must wait a minimum 5 minutes to let excess gas dissipate before lighting again.



13 SUPA  
13 78 72  
supagas.com.au

This heater is approved for outdoor use only.



**SUPAGAS**  
YES WE CAN!

# Patio Heater

**Note:** The definition of outdoors is an above ground open-air situation with natural ventilation, without stagnant areas, where gas leakage and products of combustion are rapidly dispersed by wind and natural convection.

Please observe these diagrammatic representations of areas that are considered outdoors.

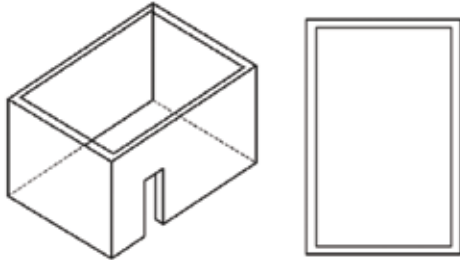

Outdoor Area - Example 1

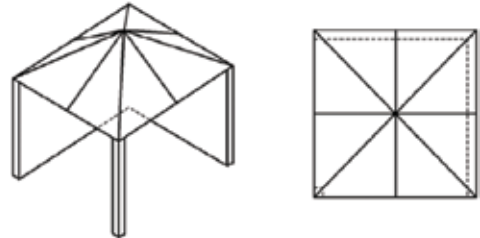

Outdoor Area - Example 2

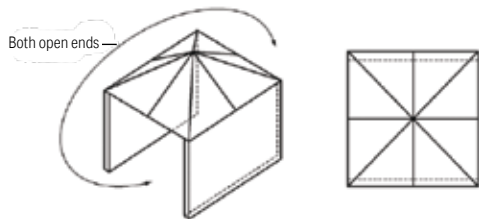

Outdoor Area - Example 3

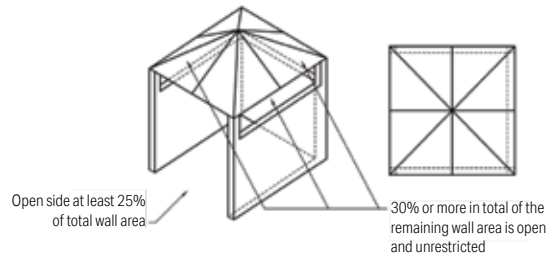

Outdoor Area - Example 4

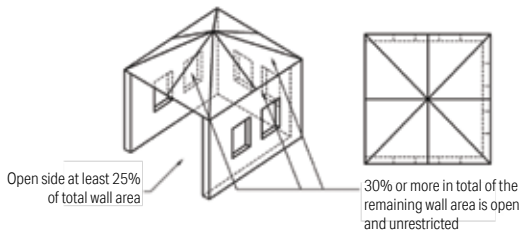

Outdoor Area - Example 5

**WARNING**  
Improper installation, adjustment, or alteration can cause personal injury and property damage.

**NOTE:** In the case of balconies or verandahs, at least 20% of the total of the side, back and front wall must remain open and unrestricted.

Please observe the following guidelines to minimum clearances required from combustibles

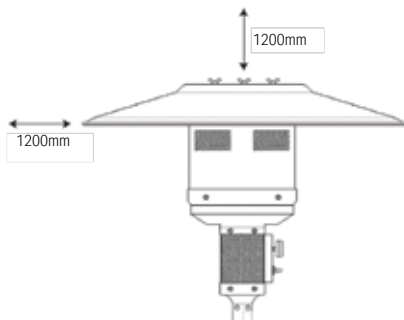

Minimum Clearances from Combustibles  
(top, sides and rear)

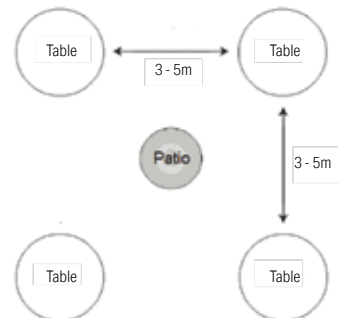

Setting up a Patio Heater

NAT-HT12 Rev 4\_19032019



**13 SUPA**  
**13 78 72**  
supagas.com.au